



CONSTANT CLIMATE CHAMBERS

Constant climate chambers

Series KBF-S ECO Solid.Line	Page 6
Series KBF	Page 14
Series KBF PRO	Page 24

BINDER constant climate chambers offer precise and reliable climate control for a wide range of applications. The double-sided airflow ensures uniform temperature and humidity distribution - even when fully loaded. The KBF series (0 °C to +70 °C, 10-80 % r.H.) is ideal for stability tests in accordance with ICH-Q1A. The energy-efficient KBF-S ECO saves up to 75 % electricity thanks to Peltier technology. The KBF PRO series enables demanding material tests (-20 °C to +100 °C, 10-98 % r.h.). Supplemented with ICH light modules, photostability tests can be carried out..

ADVANTAGES AT A GLANCE



SAFE AND POWERFUL

KBF PRO with a wide temperature range from -20 °C to +100 °C for demanding tests.



UNLIMITED FLEXIBILITY

Wide range of applications thanks to large product portfolio with compressor or Peltier units, as table-top or floor-standing units up to 1600 L. The cooling incubators can be individually adapted to requirements with a wide range of accessories.



MODULARITY THAT GROWS WITH YOU

KBF, KBF PRO

Modular equipment options, such as light modules, can be retrofitted at any time. Light modules turn the climate chamber into a photostability test chamber or plant growth chamber.



NEW STANDARDS IN ENERGY EFFICIENCY

Exemplary environmental friendliness thanks to maximum energy efficiency and avoidance of climate-damaging refrigerants.

Series KBF-S ECO Solid.Line | with environmentally friendly thermoelectric cooling

Thanks to thermoelectric cooling technology with patented heat dissipation, the new KBF-S ECO climatic chamber is one of the most energy-efficient constant climate chambers on the market. The thermoelectric cooling technology means the KBF-S ECO series is also very quiet during operation.



Model 720

BENEFITS

- Safe thanks to standard-compliant testing according to the ICH Q1A guideline, even with full load.
- Reliable thanks to failsafe operation without compromise.
- Smart, as a wide range of accessories makes it highly compatible for adaptation to specific customer requirements.
- Economical, as energy consumption is minimal thanks to optimized thermoelectric cooling.

IMPORTANT CHARACTERISTICS

- Temperature range: 0 °C to +70 °C (max. 28 °C under ambient temperature)
- Humidity range: 10% to 80% RH
- APT.line™ preheating chamber technology
- Independent water supply via tank
- LCD to display temperature and humidity along with additional information and alarms
- Internal data logger, measured values can be read out in open format via USB
- Unit self-test for comprehensive status analysis
- Inner chamber made completely of stainless steel
- 2 stainless steel racks, including shelf carrier
- Access port with silicone plug Ø 30 mm, left
- Computer interface: Ethernet

AVAILABLE SIZES

Designation	Interior volume	Kurz-URL
KBF-S ECO 240	247	› go2binder.com/en-KBF-S-ECO240
KBF-S ECO 400	400	› go2binder.com/en-KBF-S-ECO400
KBF-S ECO 720	700	› go2binder.com/en-KBF-S-ECO720
KBF-S ECO 1020	1,020	› go2binder.com/en-KBF-S-ECO1020

OPTIONAL EQUIPMENT

Access port with silicone plug

For introducing external measuring instruments. Large selection of different diameters and positions (left, right, or top)

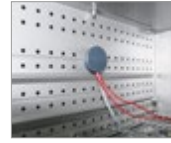
**BINDER PURE AQUA Service**

System for preparation or complete desalination of tap water, complete set containing PURE AQUA 300 single-use cartridge, measuring device, and all necessary connecting parts.

**LED light bar sets**

LED light bars in three different lengths (30, 50, 90 cm) can be easily and variably positioned in the BINDER unit, including various attachment options and control unit. Additional light bars can be added as desired.

**Services**

You can access our installation, maintenance, calibration, validation, or warranty services by taking out a Maintenance Service Agreement or by simply getting in touch when you need us. More information is available in the accessories and services chapter.



► Alle Extras Online go2binder.com/de-Optionen

TECHNICAL DATA

Data				
Designation	KBF-S ECO 240	KBF-S ECO 400	KBF-S ECO 720	KBF-S ECO 1020
Option model	Standard	Standard	Standard	Standard
Performance Data Temperature				
Temperature range	(max. 28 °C under ambient temperature) 0...70 °C	(max. 26 °C under ambient temperature) 0...70 °C	(max. 24 °C under ambient temperature) 0...70 °C	(max. 24 °C under ambient temperature) 0...70 °C
Max. heat compensation at 40°C	250 W	300 W	400 W	400 W
Performance Data Climate				
Temperature range with humidity	(max. 28 °C under ambient temperature) 5...70 °C	(max. 26 °C under ambient temperature) 5...70 °C	(max. 24 °C under ambient temperature) 5...70 °C	(max. 24 °C under ambient temperature) 5...70 °C
Humidity range	10...80 % RH	10...80 % RH	10...80 % RH	10...80 % RH
Temperature uniformity at 25°C and 60% RH	0.1 ± K	0.1 ± K	0.1 ± K	0.1 ± K
Temperature uniformity at 40°C and 75% RH	0.2 ± K	0.5 ± K	0.3 ± K	0.5 ± K
Temperature fluctuation at 25°C and 60% RH	0.1 ± K	0.1 ± K	0.1 ± K	0.1 ± K
Temperature fluctuation at 40°C and 75% RH	0.1 ± K	0.1 ± K	0.1 ± K	0.1 ± K
Humidity fluctuation at 25°C and 60% RH	0.3 ± % RH	0.3 ± % RH	0.3 ± % RH	0.4 ± % RH
Humidity fluctuation at 40°C and 75% RH	0.3 ± % RH	0.3 ± % RH	0.3 ± % RH	0.4 ± % RH
Recovery time after door was opened for 30 s at 25°C and 60% RH	5 min	6 min	7 min	5 min
Recovery time after door was opened for 30 s at 40°C and 75% RH	11 min	15 min	17 min	15 min
Electrical data				
Power frequency	50/60 Hz			
Nominal power	0,8 kW	1,1 kW	1,2 kW	1,2 kW
Unit fuse	16,0 A	16,0 A	16,0 A	16,0 A
Phase (Nominal voltage)	1~	1~	1~	1~
Dimensions and weights				
Interior volume	247 L	400 L	700 L	1,020 L
Net weight of the unit (empty)	146 kg	192 kg	267 kg	322 kg
Load per rack	30 kg	30 kg	45 kg	45 kg
Permitted load	100 kg	120 kg	150 kg	150 kg
Wall clearance back	100 mm	100 mm	100 mm	100 mm
Wall clearance sidewise	180 mm	180 mm	180 mm	180 mm
Housing dimensions not incl. fittings and connections				
Width net	932 mm	925 mm	1,254 mm	1,254 mm
Height net	1,461 mm	1,946 mm	1,925 mm	1,925 mm
Depth net	796 mm	796 mm	885 mm	1,146 mm
Internal Dimensions				
Interior width	650 mm	650 mm	973 mm	973 mm
Interior height	785 mm	1,268 mm	1,250 mm	1,250 mm
Interior depth	485 mm	485 mm	576 mm	836 mm
Unit doors	1	1	2	2

Environment-specific data				
Sound-pressure level	46 dB(A)	45 dB(A)	48 dB(A)	49 dB(A)
Energy consumption at 25°C and 60% RH	55 Wh/h	60 Wh/h	90 Wh/h	90 Wh/h
Energy consumption at 40°C and 75% RH	85 Wh/h	70 Wh/h	130 Wh/h	135 Wh/h
Fixtures				
Number of shelves (std./max.)	2/9	2/15	2/15	2/15

ORDERING INFORMATION

Interior volume [L]	Power supply - unit fuse	Plug*	Version	Model version	Art.-No.
Model KBF-S ECO 240					
247	100...120 V 1~ 50/60 Hz -16,0 A	NEMA 5-20	Standard	KBFSEC-0240UL-120V	9020-0420
	200...230 V 1~ 50/60 Hz -16,0 A	CEE 7/7	Standard	KBFSECO240-230V	9020-0416
Model KBF-S ECO 400					
400	100...120 V 1~ 50/60 Hz -16,0 A	NEMA 5-20	Standard	KBFSEC-0400UL-120V	9020-0464
	200...230 V 1~ 50/60 Hz -16,0 A	CEE 7/7	Standard	KBFSECO400-230V	9020-0463
Model KBF-S ECO 720					
700	100...120 V 1~ 50/60 Hz -16,0 A	NEMA 5-20	Standard	KBFSEC-0720UL-120V	9020-0421
	200...230 V 1~ 50/60 Hz -16,0 A	CEE 7/7	Standard	KBFSECO720-230V	9020-0418
Model KBF-S ECO 1020					
1,020	100...120 V 1~ 50/60 Hz -16,0 A	NEMA 5-20	Standard	KBFSEC-01020UL-120V	9020-0422
	200...230 V 1~ 50/60 Hz -16,0 A	CEE 7/7	Standard	KBFSECO1020-230V	9020-0419

EXTRACT OF FULFILLED STANDARDS

- ICH Q1A(R2)

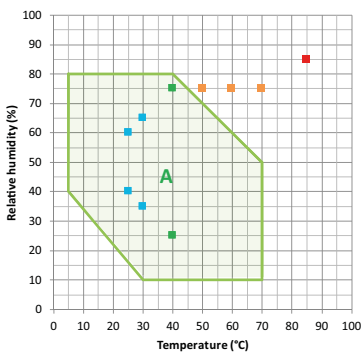

- ICH Long term stability testing
 - Accelerated stability testing
 - ICH Stress testing
 - Industrial THB testing (85/85)
- A: Guaranteed condensation-free range

DIMENSIONS AND WEIGHTS

KBF-S ECO 240

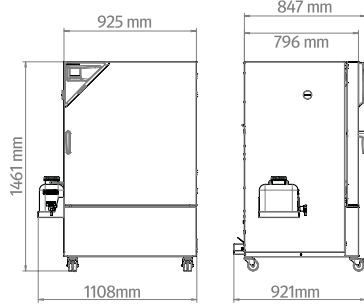

KBF-S ECO 400

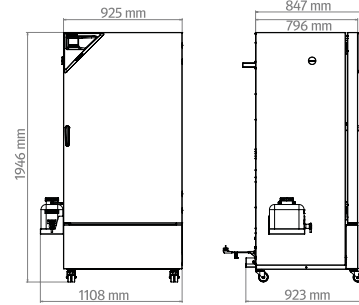

KBF-S ECO 720

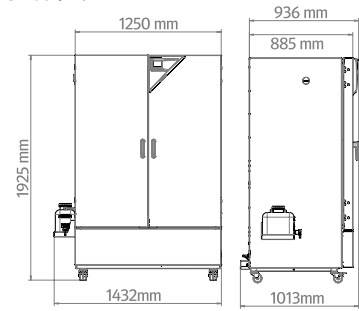

KBF-S ECO 1020

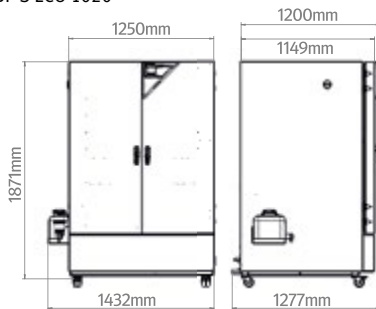

OPTIONS

Designation	Description	KBF-S	KBF-S	KBF-S	KBF-S	*	Art.-No.
		ECO 240	ECO 400	ECO 720	ECO 1020		
Access port with silicone plug	left						
	30 mm	•	•	•	•	01	8012-2072
	50 mm	•	•	•	•	01	8012-2079
	100 mm	•	•	•	•	01	8012-2077
	right						
	30 mm	•	•	•	•	01	8012-2071
	50 mm	•	•	•	•	01	8012-2078
	100 mm	•	•	•	•	01	8012-2076
	top						
	30 mm	•	•	•	•	01	8012-2073
50 mm	•	•	•	•	01	8012-2074	
100 mm	•	•	•	•	01	8012-2075	
Calibration certificate, expanded	for temperature and humidity; for extending the measurement in center of chamber to include another test value	•	•	•	•	-	8012-2066
Calibration certificate, temperature	temperature measurement incl. certificate, 9 measuring points at specified temperature	•	•	•	•	-	8012-2067
	temperature measurement incl. certificate, 15- 18 measuring points at specified temperature	•	•	•	•	-	8012-2068
	temperature measurement incl. certificate and 27 measuring points at specified temperature	•	•	•	•	-	8012-2069

Designation	Description	KBF-S	KBF-S	KBF-S	KBF-S	*	Art.-No.
		ECO 240	ECO 400	ECO 720	ECO 1020		
Calibration certificate, temperature and humidity	Measurement in center of chamber at 25°C / 60% RH or at specified test values	•	•	•	•	-	8012-2065
	temperature (according to DIN12880) and humidity measurement incl. certificate, 27 temperature measuring points and 1 humidity measuring point, at 25 °C / 60 % RH or at specified values	•	•	•	•	-	8012-2070
Door lock	lockable door handle	•	•	-	-	-	8012-2086
		-	-	•	•	-	8012-2087

ACCESSORIES

Designation	Description	KBF-S	KBF-S	KBF-S	KBF-S	*	Art.-No.
		ECO 240	ECO 400	ECO 720	ECO 1020		
APT-COM™ 4 BASIC-Edition	for simple logging and documentation requirements with up to 5 networked units. version 4, BASIC edition	•	•	•	•	-	9053-0039
APT-COM™ 4 GLP-Edition	for working under GLP-compliant conditions. Measured values are documented in a tamper-proof way in line with the requirements of FDA Regulation 21 CFR 11. version 4, GLP edition	•	•	•	•	-	9053-0042
APT-COM™ 4 PROFESSIONAL-Edition	convenient unit and user management built on the BASIC edition. Suitable for networking up to 100 units. version 4, PROFESSIONAL edition	•	•	•	•	-	9053-0040
BINDER PURE AQUA SERVICE	System for preparation or complete desalination of tap water, complete set containing PURE AQUA 300 single-use cartridge, measuring device, and all necessary connecting parts	•	•	•	•	-	8012-0759
BINDER PURE AQUA SERVICE, accessories	Single-use, replacement cartridge for BINDER PURE AQUA System	•	•	•	•	-	6011-0165
Convenient water supply	Flexible positioning of the water container with magnetic holder, hose adapter for water container with practical quick coupling, and water stop function						
	External, with magnetic holder	•	•	•	•	-	8012-1847
LED light bars	Basic set consisting of 2 pieces, attachment material, control unit for max. 4 light strips, 100-240 V, 50/60 Hz						
	Basic set 300, length 30 cm	•	•	•	•	-	8012-1107
	Basic set 500, length 50 cm	•	•	•	•	-	8012-1108
	Basic set 900, length 90 cm	-	-	•	•	-	8012-1109
	Expansion set consisting of 2 pieces, attachment material: clips. For expanding the basic set of light bars						
	Expansion set 300, length 30 cm	•	•	•	•	-	8012-1716
	Expansion set 500, length 50 cm	•	•	•	•	-	8012-1717
	Expansion set 900, length 90 cm	-	-	•	•	-	8012-1718
pH-neutral detergent	concentrated, for gentle remove of residual contaminants; 1 kg	•	•	•	•	-	8012-2250

Designation	Description	KBF-S	KBF-S	KBF-S	KBF-S	*	Art.-No.	
		ECO 240	ECO 400	ECO 720	ECO 1020			
Qualification documents	IQ/OQ/PQ documents – supporting documents for validation performed by customers, according to customer requirements, PQ section added to qualification folder IQ/OQ; parameters: temperature and humidity values	•	•	•	•	-	7057-0006	
		•	•	•	•	-	7007-0006	
	IQ/OQ documents – supporting documents for validation performed by customers, consisting of: IQ/OQ checklists incl. calibration guide and comprehensive unit documentation; parameters: temperature and humidity values	•	•	•	•	-	7057-0002	
		•	•	•	•	-	7007-0002	
	Rack	stainless steel	•	•	-	-	-	8012-2050
			-	-	•	-	-	8012-2051
-			-	-	•	-	8012-2052	
Rack, reinforced	stainless steel, with fasteners (1 set of 4)	•	•	-	-	-	8012-0638	
		-	-	•	-	-	8012-0674	
		-	-	-	•	-	8012-0968	
Rack accessories	fasteners (1 set of 4) for additional security of racks	•	•	•	•	-	8012-2280	
		•	•	-	-	-	8012-2163	
Shelf, perforated	Stainless steel	-	-	•	-	-	8012-2252	
		-	-	-	•	-	8012-2254	

SERVICES

Designation	Description	*	Art.-No.
1-year warranty extension	The warranty is extended by 1 year from the delivery date, wear parts are excluded	-	DL50-0030
BRONZE 3-year maintenance contract	Maintenance service as contractually agreed, visual inspection of mechanical and electrical components, check of control response, 20% discount on spare parts	-	DL20-0710
Execution of IQ/OQ	Execution of IQ/OQ in accordance with qualification folder	-	DL42-0300
Execution of IQ/OQ/PQ	Execution of IQ/OQ/PQ in accordance with qualification folder	-	DL44-0500
GOLD 3-year maintenance contract	Maintenance service as contractually agreed, visual inspection of mechanical and electrical components, check of control response, 20% discount on spare parts, testing of all key functions, replacement of wear parts, calibration of one test temperature specified by the user in the center of the usable space, including certificate	-	DL20-0925
Maintenance	One-off maintenance service in accordance with maintenance schedule. Visual inspection of mechanical and electrical components, testing of all key functions. Calibration of a test temperature specified by the user in center of usable space without certificate	-	DL20-0605
SILVER 3-year maintenance contract	Maintenance service as contractually agreed, visual inspection of mechanical and electrical components, check of control response, 20% discount on spare parts, testing of all key functions, calibration of one test temperature specified by the user in the center of the usable space, without certificate	-	DL20-0825
Temperature and humidity calibration	Expansion –Temperature and humidity calibration with 1 measuring point in center of chamber with 1 specified pair of values, including certificate	-	DL30-0302
	Temperature and humidity calibration with 1 measuring point in center of chamber with 1 specified pair of values, including certificate	-	DL30-0310
Temperature and humidity measurement, 9-1 measuring points	Temperature measurement with 9 temperature measuring points and 1 humidity measuring point in center of chamber with a pair of values specified by the user, including certificate	-	DL30-0309
Temperature and humidity measurement, 18-1 measuring points	Temperature measurement with 18 temperature measuring points and 1 humidity measuring point in center of chamber with a pair of values specified by the user, including certificate	-	DL30-0318
Temperature and humidity measurement, 27-1 measuring points	Temperature measurement with 27 temperature measuring points and 1 humidity measuring point in center of chamber with a pair of values specified by the user, including certificate	-	DL30-0327

Designation	Description	*	Art.-No.
Temperature and humidity measurement according to DIN12880	Temperature measurement in accordance with DIN 12880 with 27 temperature measuring points and 1 humidity measuring point in center of chamber with a pair of values specified by the user, including certificate	-	DL30-0427
Unit commissioning	Connect the unit to the customer-side connections (electricity, water, wastewater, gas), basic functions check, brief operating instructions. (excl.: unpacking, setup, controller instructions, programming, installation work)	-	DL10-0300
Unit instructions	Instruction regarding operating principle and basic functions of the unit, operation of the control electronics including programming	05	DL10-0700

Series KBF | with a large temperature / humidity range

The proven specialist for reliable ICH stability tests in the pharmaceutical industry: the KBF masters all long-term tests, accelerated tests and stress tests. It fulfills all important ICH requirements, from precision to programming and documentation. With flexible water supply options for all installation locations. In addition, the new KBF consumes up to 40 % less energy than its predecessor.



Model 470

BENEFITS

- A reliable option for critical ICH stability testing thanks to maximum climate homogeneity, even when the unit is fully loaded
- Reliable: failsafe operation over the long term thanks to proven compressor technology and interior made of stainless steel
- Smart: signal triangle with light-up status display and ergonomic control terminal with touchscreen program controller
- Economical: up to 40% lower energy consumption than the previous model thanks to modern inverter cooling technology







IMPORTANT CHARACTERISTICS

- Temperature range: 0°C to +70°C
- Humidity range: 10% to 80% RH
- Proven APT.line™ preheating chamber technology
- Up to 40% lower energy consumption compared to the previous model
- Energy-efficient cooling with modern inverter cooling unit
- Cooling with climate-neutral R-600a refrigerant
- Door heating to prevent condensation
- Adjustable fan speed
- Humidity regulation with capacitive humidity sensor and responsive steam humidification
- Robust housing design with HIT sandwich technology
- Stainless-steel inner chamber
- Inner doors made of metal oxide-coated safety glass
- Two racks made of stainless steel
- Large access port with silicone plug
- Tabletop units (up to model 130) are stackable with stacking adapter
- Floor-standing units (from model 260) featuring robust twin casters, with brakes at the front
- Intuitive touchscreen controller with time-segment and real-time programming
- Ergonomically adjustable control terminal (from model 470)
- Signal triangle with light-up status display (from model 470)
- Internal data logger, measured values can be read out in open format via USB
- Class 3.3 independent temperature safety device (DIN 12880) with visual and acoustic alarms
- Unit self-test for comprehensive status analysis
- Data interfaces: Ethernet, USB
- BINDER Multi Management Software APT-COM™ basic edition
- Optional light modules for ICH photostability testing (for models 260, 470, 720)
- Optional LED light modules for plant growth (for models from 260)

AVAILABLE SIZES

Designation	Interior volume	Kurz-URL
KBF 130	127	> go2binder.com/en-KBF130
KBF 260	262	> go2binder.com/en-KBF260
KBF 470	472	> go2binder.com/en-KBF470
KBF 720	727	> go2binder.com/en-KBF720
KBF 1060	1,070	> go2binder.com/en-KBF1060
KBF 1600	1,610	> go2binder.com/en-KBF1600

OPTIONAL EQUIPMENT

ICH-Lighting module	<p>Light cassettes and supply module for upgrading a cooling incubator to a photostability test chamber. Can be retrofitted in two versions with or without light sensors for light dose control (LQC). Complies with ICH guideline Q1B.</p> <p>KBF, KBF PRO 260, 470, 720</p>	
Plant Lighting module	<p>LED light strips with supply module and control unit for the three light channels warm white, cool white and dark red. The light strips can be positioned flexibly and are attached to standard slide-in grids</p> <p>KBF; KBF PRO 260, 470, 720, 1060, 1600</p>	
CO2 Gassing module	<p>The free-standing units in the KB PRO series can be retrofitted with a CO2 gassing module. Control ranges 0-1 vol.-% CO2 for plants or 0-20 vol.-% CO2 for cell cultures.</p> <p>KBF PRO 260, 470, 720</p>	
Water treatment	<p>BINDER PURE AQUA Service for the treatment or demineralization of tap water for the humidification systems of BINDER climate chambers. The complete set containing PURE AQUA 300 single-use cartridge, measuring device, and all necessary connecting parts.</p>	
Services	<p>You can access our installation, maintenance, calibration, validation, or warranty services by taking out a Maintenance Service Agreement or by simply getting in touch when you need us.</p>	
BINDER Customized Solution	<p>Using a BINDER series production product as a basis, we develop individual solutions as a single unit or in small batches. All products are tested, certified, and supplied with a full functional guarantee and warranty.</p>	

► Alle Extras Online go2binder.com/de-Optionen

TECHNICAL DATA

Data						
Designation	KBF 130	KBF 260	KBF 470	KBF 720	KBF 1060	KBF 1600
Option model	Standard	Standard	Standard	Standard	Standard	Standard
Performance Data Temperature						
Temperature range	0...70 °C	0...70 °C	0...70 °C	0...70 °C	0...70 °C	0...70 °C
Max. heat compensation at 40°C	270 W	410 W	530 W	640 W	640 W	640 W
Performance Data Climate						
Temperature range with humidity	10...70 °C	10...70 °C	10...70 °C	10...70 °C	10...70 °C	10...70 °C
Humidity range	10...80 % RH	10...80 % RH	10...80 % RH	10...80 % RH	10...80 % RH	10...80 % RH
Temperature uniformity at 25°C and 60% RH	0.2 ± K	0.3 ± K	0.2 ± K	0.3 ± K	0.3 ± K	0.4 ± K
Temperature uniformity at 40°C and 75% RH	0.2 ± K	0.2 ± K	0.2 ± K	0.2 ± K	0.2 ± K	0.3 ± K
Temperature fluctuation at 25°C and 60% RH	0.1 ± K	0.1 ± K	0.1 ± K	0.1 ± K	0.1 ± K	0.1 ± K
Temperature fluctuation at 40°C and 75% RH	0.1 ± K	0.1 ± K	0.1 ± K	0.1 ± K	0.1 ± K	0.1 ± K
Humidity fluctuation at 25°C and 60% RH	1.5 ± % RH	1.5 ± % RH	1.5 ± % RH	1.5 ± % RH	1.5 ± % RH	1.5 ± % RH
Humidity fluctuation at 40°C and 75% RH	1.5 ± % RH	1.5 ± % RH	1.5 ± % RH	1.5 ± % RH	1.5 ± % RH	1.5 ± % RH
Recovery time after door was opened for 30 s at 25°C and 60% RH	3 min	1 min	1 min	1 min	2 min	2 min
Recovery time after door was opened for 30 s at 40°C and 75% RH	3 min	3 min	4 min	5 min	5 min	6 min
Electrical data						
Power frequency	50/60 Hz	50/60 Hz	50/60 Hz	50/60 Hz	50/60 Hz	50/60 Hz
Nominal power	1,3 kW	1,4 kW	1,4 kW	1,6 kW	1,6 kW	1,7 kW
Unit fuse	16,0 A	16,0 A	16,0 A	16,0 A	16,0 A	16,0 A
Phase (Nominal voltage)	1~	1~	1~	1~	1~	1~
Dimensions and weights						
Interior volume	127 L	262 L	472 L	727 L	1,070 L	1,610 L
Net weight of the unit (empty)	126 kg	188 kg	225 kg	298 kg	340 kg	438 kg
Load per rack	25 kg	30 kg	40 kg	40 kg	40 kg	40 kg
Permitted load	50 kg	90 kg	90 kg	100 kg	100 kg	100 kg
Wall clearance back	100 mm	100 mm	100 mm	100 mm	100 mm	100 mm
Wall clearance sidewise	100 mm	180 mm	180 mm	180 mm	180 mm	180 mm
Housing dimensions not incl. fittings and connections						
Width net	900 mm	930 mm	930 mm	1,285 mm	1,285 mm	1,795 mm
Height net	1,005 mm	1,396 mm	1,951 mm	1,951 mm	1,951 mm	1,951 mm
Depth net	710 mm	900 mm	900 mm	900 mm	1,175 mm	1,175 mm

Internal Dimensions						
Interior width	656 mm	656 mm	656 mm	1,011 mm	1,011 mm	1,521 mm
Interior height	500 mm	695 mm	1,250 mm	1,250 mm	1,250 mm	1,250 mm
Interior depth	386 mm	575 mm	575 mm	575 mm	847 mm	847 mm
Inner doors	1	1	1	2	2	2
Unit doors	1	1	1	2	2	2
Environment-specific data						
Sound-pressure level at 25°C and 60% RH	47 dB(A)	50 dB(A)	51 dB(A)	51 dB(A)	52 dB(A)	54 dB(A)
Fixtures						
Number of shelves (std./max.)	2/6	2/9	2/16	2/16	2/16	2/16

ORDERING INFORMATION

Interior volume [L]	Power supply - unit fuse	Plug*	Version	Model version	Art.-No.
Model KBF 130					
127	120 V 1~ 50/60 Hz -16,0 A	NEMA 5-20	Standard	KBF130UL-120V	9020-0494
	200...240 V 1~ 50/60 Hz -16,0 A	CEE 7/7	Standard	KBF130-230V	9020-0478
Model KBF 260					
262	120 V 1~ 50/60 Hz -16,0 A	NEMA 5-20	Standard	KBF260UL-120V	9020-0495
	220...240 V 1~ 50/60 Hz -16,0 A	CEE 7/7	Standard	KBF260-230V	9020-0479
Model KBF 470					
472	120 V 1~ 50/60 Hz -16,0 A	NEMA 5-20	Standard	KBF470UL-120V	9020-0496
	220...240 V 1~ 50/60 Hz -16,0 A	CEE 7/7	Standard	KBF470-230V	9020-0480
Model KBF 720					
727	120 V 1~ 50/60 Hz -16,0 A	NEMA 5-20	Standard	KBF720UL-120V	9020-0497
	220...240 V 1~ 50/60 Hz -16,0 A	CEE 7/7	Standard	KBF720-230V	9020-0481
Model KBF 1600					
1,610	120 V 1~ 50/60 Hz -16,0 A	NEMA 5-20	Standard	KBF1600UL-120V	9020-0499
	220...240 V 1~ 50/60 Hz -16,0 A	CEE 7/7	Standard	KBF1600-230V	9020-0483
Modell KBF 1060					
1,070	120 V 1~ 50/60 Hz -16,0 A	NEMA 5-20	Standard	KBF1060UL-120V	9020-0498
	220...240 V 1~ 50/60 Hz -16,0 A	CEE 7/7	Standard	KBF1060-230V	9020-0482

EXTRACT OF FULFILLED STANDARDS

- ICH Q1A(R2)

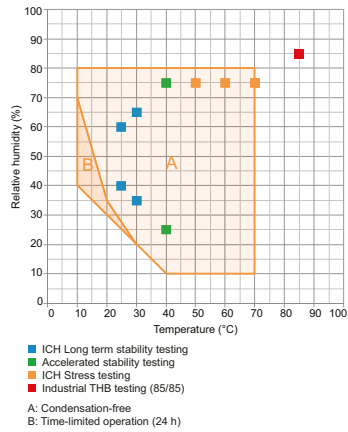

DIMENSIONS AND WEIGHTS

KBF 130

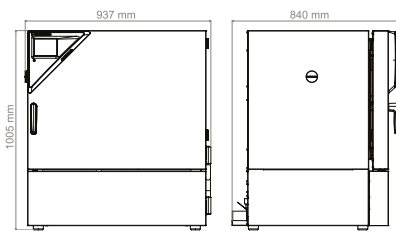

KBF 260

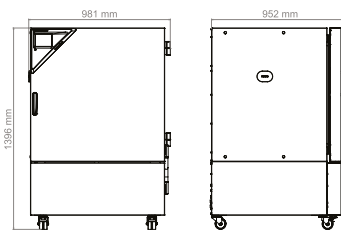

KBF 470

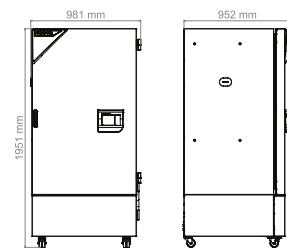

KBF 720

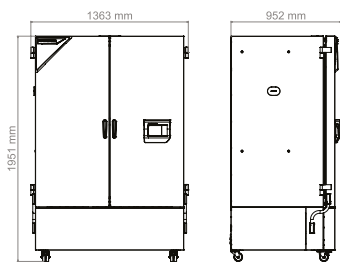

KBF 1060

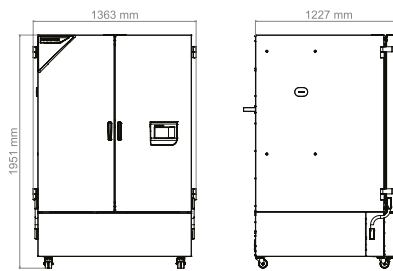

KBF 1600

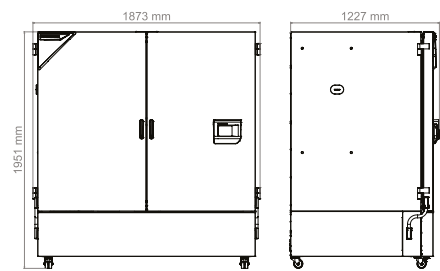

OPTIONS

Designation	Description	KBF 130	KBF 260	KBF 470	KBF 720	KBF 1060	KBF 1600	*	Art.-No.
Access port with silicone plug	left								
	30 mm	•	•	•	•	•	•	01	8012-2481
	50 mm	•	•	•	•	•	•	01	8012-2482
	100 mm	–	•	•	•	•	•	01	8012-2483
	right								
	30 mm	•	•	•	•	•	•	01	8012-2484
	50 mm	•	•	•	•	•	•	01	8012-2485
	100 mm	–	•	•	•	•	•	01	8012-2486
	top								
	30 mm	•	•	•	•	•	•	01	8012-2499
	50 mm	•	•	•	•	•	•	01	8012-2487
	100 mm	•	•	•	•	•	•	01	8012-2488
Alarm output, zero-voltage	Accessible via 3-pin clamping sleeve (max. 24 V - 2.5 A), with acoustic signal that can be switched off	•	•	•	•	•	•	-	8012-2503
Analog output 4-20 mA	for temperature and humidity values (output not adjustable)	•	•	•	•	•	•	-	8012-2574
Calibration certificate, expanded	for temperature and humidity; for extending the measurement in center of chamber to include another test value	•	•	•	•	•	•	-	8012-2575
Calibration certificate, temperature	temperature measurement incl. certificate, 9 measuring points at specified temperature	•	•	•	•	•	•	-	8012-2378
	temperature measurement incl. certificate, 15- 18 measuring points at specified temperature	•	•	•	•	•	•	-	8012-2382
	temperature measurement incl. certificate and 27 measuring points at specified temperature	•	•	•	•	•	•	-	8012-2426
Calibration certificate, temperature and humidity	Measurement in center of chamber at 25°C / 60% RH or at specified test values	•	•	•	•	•	•	-	8012-2437
	temperature (according to DIN12880) and humidity measurement incl. certificate, 27 temperature measuring points and 1 humidity measuring point, at 25 °C / 60 % RH or at specified values	•	•	•	•	•	•	-	8012-2577
Door lock	lockable door handle	•	•	•	–	–	–	-	8012-2535
		–	–	–	•	•	•	-	8012-2536
Door lock, electromechanical	can be opened with PIN code via controller	•	•	•	–	–	–	-	8012-2537
		–	–	–	•	•	•	-	8012-2589
Inner chamber, reinforced	max. total load 100 kg	•	–	–	–	–	–	-	8012-2518
	max. total load 180 kg	–	•	–	–	–	–	-	8012-2519
	max. total load 200 kg	–	–	•	–	–	–	-	8012-2520
	max. total load 200 kg	–	–	–	•	–	–	-	8012-2521
	max. total load 200 kg	–	–	–	–	•	–	-	8012-2522
Interior lighting	With climate-resistant LEDs, switches when the unit door is opened	•	•	•	–	–	–	-	8012-2561
		–	–	–	•	•	–	-	8012-2565
		–	–	–	–	–	•	-	8012-2569

Designation	Description	KBF 130	KBF 260	KBF 470	KBF 720	KBF 1060	KBF 1600	*	Art.-No.
LED light bars	Basic set consisting of 2 pieces, attachment material, control unit for max. 4 light strips, 100-240 V, 50/60 Hz								
	Basic set 300, length 30 cm	-	-	•	-	-	-	-	8012-1107
	Basic set 500, length 50 cm	-	-	•	-	-	-	-	8012-1108
	Expansion set consisting of 2 pieces, attachment material: clips. For expanding the basic set of light bars								
	Expansion set 300, length 30 cm	-	-	•	-	-	-	-	8012-1716
	Expansion set 500, length 50 cm	-	-	•	-	-	-	-	8012-1717
Shipping pallet	with unloading ramp for installing unit without forklift	-	•	•	•	•	•	-	8012-2547
Specimen temperature display	Flexible Pt 100 indoor temperature sensor, for object temperature display or control	•	•	•	•	•	•	-	8012-2591
Swivel casters, height-adjustable	For horizontal alignment of the unit on uneven floors	-	•	•	•	•	•	-	8012-2543

ACCESSORIES

Designation	Description	KBF 130	KBF 260	KBF 470	KBF 720	KBF 1060	KBF 1600	*	Art.-No.
APT-COM™ 4 GLP-Edition	for working under GLP-compliant conditions. Measured values are documented in a tamper-proof way in line with the requirements of FDA Regulation 21 CFR 11.								
	version 4, GLP edition	•	•	•	•	•	•	-	9053-0042
APT-COM™ 4 PROFESSIONAL-Edition	convenient unit and user management built on the BASIC edition. Suitable for networking up to 100 units.								
	version 4, PROFESSIONAL edition	•	•	•	•	•	•	-	9053-0040
Base	With swivel casters, for mobile installation or leveling of the unit or stack of units	•	-	-	-	-	-	-	9051-0045
BINDER PURE AQUA SERVICE	System for preparation or complete desalination of tap water, complete set containing PURE AQUA 300 single-use cartridge, measuring device, and all necessary connecting parts	•	•	•	•	•	•	-	8012-0759
BINDER PURE AQUA SERVICE, accessories	Single-use, replacement cartridge for BINDER PURE AQUA System	•	•	•	•	•	•	-	6011-0165
CO ₂ gassing module	BINDER CO ₂ gassing module 0-1%, with NDIR CO ₂ sensor and analog output 4-20 mA	-	-	•	•	•	•	-	8012-2140
	BINDER CO ₂ gassing module 0-20%, with NDIR CO ₂ sensor and analog output 4-20 mA	-	-	•	•	•	•	-	8012-2138
ICH light module	BINDER ICH-Q1B light module consisting of a VIS cassette and a UVA cassette as well as an independent power supply	-	•	•	-	-	-	-	8012-2441
		-	-	-	•	-	-	-	8012-2442
ICH light module with LQC	BINDER ICH-Q1B light module with light-dose control consisting of a VIS cassette, a UVA cassette, a spherical VIA sensor, a spherical UVA sensor as well as an independent power supply	-	•	•	-	-	-	-	8012-2443
		-	-	-	•	-	-	-	8012-2444

Designation	Description	KBF	KBF	KBF	KBF	KBF	KBF	*	Art.-No.
		130	260	470	720	1060	1600		
LED light bars	Basic set consisting of 2 pieces, attachment material, control unit for max. 4 light strips, 100-240 V, 50/60 Hz								
	Basic set 300, length 30 cm	•	•	-	-	-	-	-	8012-1107
	Basic set 500, length 50 cm	•	•	-	•	•	•	-	8012-1108
	Basic set 900, length 90 cm	-	-	-	•	•	•	-	8012-1109
	Expansion set consisting of 2 pieces, attachment material: clips. For expanding the basic set of light bars								
	Expansion set 300, length 30 cm	•	•	-	-	-	-	-	8012-1716
	Expansion set 500, length 50 cm	•	•	-	•	•	•	-	8012-1717
Light module for plants	Expansion set 900, length 90 cm	-	-	-	•	•	•	-	8012-1718
	BINDER LED plant light module consisting of 16 LED strip lights, 3-channel controller and fresh air pump as well as independent power supply	-	•	•	•	•	•	-	8012-2439
	pH-neutral detergent	•	•	•	•	•	•	-	8012-2250
Qualification documents	concentrated, for gentle remove of residual contaminants; 1 kg	•	•	•	•	•	•	-	8012-2250
	IQ/OQ/PQ documents – supporting documents for validation performed by customers, according to customer requirements, PQ section added to qualification folder IQ/OQ; parameters: temperature and humidity values								
	Digital in PDF format	•	•	•	•	•	•	-	7057-0006
	Hard copy inside folder	•	•	•	•	•	•	-	7007-0006
	IQ/OQ documents – supporting documents for validation performed by customers, consisting of: IQ/OQ checklists incl. calibration guide and comprehensive unit documentation; parameters: temperature and humidity values								
Reinforced rack	Digital in PDF format	•	•	•	•	•	•	-	7057-0002
	Hard copy inside folder	•	•	•	•	•	•	-	7007-0002
	Shelf rack in set with pair of retaining rails (U rails), made entirely of stainless steel								
	Load-bearing capacity 50 kg	•	-	-	-	-	-	-	8012-2412
	Load-bearing capacity 80 kg	-	•	•	-	-	-	-	8012-2413
Shelf rack, perforated	Load-bearing capacity 80 kg	-	-	-	•	-	-	-	8012-2414
	Load-bearing capacity 80 kg	-	-	-	-	•	-	-	8012-2415
	Shelf rack in set with pair of retaining rails (U rails), made entirely of stainless steel								
	Load-bearing capacity 25 kg	•	-	-	-	-	-	-	8012-2406
	Load-bearing capacity 40 kg	-	•	•	-	-	-	-	8012-2407
Stacking adapter	Load-bearing capacity 40 kg	-	-	-	•	-	-	-	8012-2408
	Load-bearing capacity 40 kg	-	-	-	-	•	-	-	8012-2409
	Load-bearing capacity 40 kg	-	-	-	-	-	•	-	8012-2410
Stacking adapter	For safe stacking of two identical units	•	-	-	-	-	-	-	9051-0048

Designation	Description	KBF 130	KBF 260	KBF 470	KBF 720	KBF 1060	KBF 1600	*	Art.-No.	
Standard rack	Shelf rack in set with pair of retaining rails (ball bearing mounted telescopic rails), made entirely of stainless steel	-	•	•	-	-	-	-	8012-2384	
		-	-	-	•	-	-	-	8012-2385	
		-	-	-	-	•	-	-	8012-2386	
		-	-	-	-	-	•	-	8012-2387	
	Standard rack	Shelf rack in set with pair of retaining rails (U rails), made entirely of stainless steel	•	-	-	-	-	-	-	8012-2389
			-	•	•	-	-	-	-	8012-2390
		Load-bearing capacity 40 kg	-	-	-	•	-	-	-	8012-2391
			-	-	-	-	•	-	-	8012-2392
			-	-	-	-	-	•	-	8012-2393
			•	•	•	•	•	•	-	8012-2592
Water supply	External, free-standing, set consisting of 20-liter fresh water canister with pump and level sensor and 20-liter waste water canister							-	8012-2592	

SERVICES

Designation	Description	*	Art.-No.
1-year warranty extension	The warranty is extended by 1 year from the delivery date, wear parts are excluded	-	DL50-0030
BRONZE 3-year maintenance contract	Maintenance service as contractually agreed, visual inspection of mechanical and electrical components, check of control response, 20% discount on spare parts	-	DL20-0710
Execution of IQ/OQ	Execution of IQ/OQ in accordance with qualification folder	-	DL42-0300
Execution of IQ/OQ/PQ	Execution of IQ/OQ/PQ in accordance with qualification folder	-	DL44-0500
GOLD 3-year maintenance contract	Maintenance service as contractually agreed, visual inspection of mechanical and electrical components, check of control response, 20% discount on spare parts, testing of all key functions, replacement of wear parts, calibration of one temperature/humidity value, including certificate	-	DL20-0920
Maintenance	One-off maintenance service in accordance with maintenance schedule. Visual inspection of mechanical and electrical components, testing of all key functions. Calibration of a test temperature specified by the user in center of usable space without certificate	-	DL20-0613
SILVER 3-year maintenance contract	Maintenance service as contractually agreed, visual inspection of mechanical and electrical components, check of control response, 20% discount on spare parts, testing of all key functions, calibration of one test temperature specified by the user in the center of the usable space, without certificate	-	DL20-0820
Temperature and humidity calibration	Expansion –Temperature and humidity calibration with 1 measuring point in center of chamber with 1 specified pair of values, including certificate	-	DL30-0302
	Temperature and humidity calibration with 1 measuring point in center of chamber with 1 specified pair of values, including certificate	-	DL30-0340
Temperature and humidity measurement, 9-1 measuring points	Temperature measurement with 9 temperature measuring points and 1 humidity measuring point in center of chamber with a pair of values specified by the user, including certificate	-	DL30-0309
Temperature and humidity measurement, 18-1 measuring points	Temperature measurement with 18 temperature measuring points and 1 humidity measuring point in center of chamber with a pair of values specified by the user, including certificate	-	DL30-0318
Temperature and humidity measurement, 27-1 measuring points	Temperature measurement with 27 temperature measuring points and 1 humidity measuring point in center of chamber with a pair of values specified by the user, including certificate	-	DL30-0327
Temperature and humidity measurement according to DIN12880	Temperature measurement in accordance with DIN 12880 with 27 temperature measuring points and 1 humidity measuring point in center of chamber with a pair of values specified by the user, including certificate	-	DL30-0427

Designation	Description	*	Art.-No.
Unit commissioning	Connect the unit to the customer-side connections (electricity, water, wastewater, gas), basic functions check, brief operating instructions. (excl.: unpacking, setup, controller instructions, programming, installation work)	-	DL10-0300
Unit instructions	Instruction regarding operating principle and basic functions of the unit, operation of the control electronics including programming	05	DL10-0700

Series KBF PRO | with expanded temperature / humidity range

A powerful all-rounder among constant climate chambers: Equipped with all kinds of sophisticated technology, the KBF PRO takes any material test in its stride – whether it takes place at -20°C or under THB conditions at +85°C and 85% relative humidity. It offers flexible water supply options for all installation sites and consumes up to 40% less energy than its predecessor, the KMF model.



Model 470

BENEFITS

- Reliable and powerful thanks to innovative temperature control technology
- Reliable: failsafe operation over the long term thanks to proven compressor technology and inner chamber made of stainless steel
- Smart: signal triangle with light-up status display, ergonomic control terminal with touchscreen program controller, rack with telescopic rails
- Efficient: low energy consumption thanks to modern inverter cooling technology







IMPORTANT CHARACTERISTICS

- Temperature range: -20°C to +100°C
- Humidity range: 10% to 98% RH
- Proven APT.line™ preheating chamber technology
- Up to 40% lower energy consumption compared to the previous model
- Energy-efficient cooling with modern inverter cooling unit
- Cooling with climate-neutral R-290 refrigerant
- Door heating to prevent condensation
- Adjustable fan speed
- Humidity regulation with capacitive humidity sensor and responsive steam humidification
- Robust housing design with HIT sandwich technology
- Stainless-steel inner chamber
- Inner doors made of metal oxide-coated safety glass
- Two racks made of stainless steel (for models from 260 with telescopic rails)
- Large access port with silicone plug
- Tabletop units (up to model 130) are stackable with stacking adapter
- Floor-standing units (from model 260) featuring robust twin casters, with brakes at the front
- Intuitive touchscreen controller with time-segment and real-time programming
- Ergonomically adjustable control terminal (from model 470)
- Signal triangle with light-up status display (from model 470)
- Internal data logger, measured values can be read out in open format via USB
- Class 3.3 independent temperature safety device (DIN 12880) with visual and acoustic alarms
- Unit self-test for comprehensive status analysis
- Data interfaces: Ethernet, USB
- BINDER Multi Management Software APT-COM™ basic edition
- Optional light modules for ICH photostability testing (for models 260, 470, 720)
- Optional LED light modules for plant growth (for models from 260)

AVAILABLE SIZES

Designation	Interior volume	Kurz-URL
KBF PRO 130	127	> go2binder.com/en-KBFPRO130
KBF PRO 260	262	> go2binder.com/en-KBFPRO260
KBF PRO 470	472	> go2binder.com/en-KBFPRO470
KBF PRO 720	727	> go2binder.com/en-KBFPRO720
KBF PRO 1060	1,070	> go2binder.com/en-KBFPRO1060
KBF PRO 1600	1,610	> go2binder.com/en-KBFPRO1600

OPTIONAL EQUIPMENT

ICH-Lighting module	<p>Light cassettes and supply module for upgrading a cooling incubator to a photostability test chamber. Can be retrofitted in two versions with or without light sensors for light dose control (LQC). Complies with ICH guideline Q1B.</p> <p>KBF, KBF PRO 260, 470, 720</p>	
Plant Lighting module	<p>LED light strips with supply module and control unit for the three light channels warm white, cool white and dark red. The light strips can be positioned flexibly and are attached to standard slide-in grids</p> <p>KBF; KBF PRO 260, 470, 720, 1060, 1600</p>	
CO2 Gassing module	<p>The free-standing units in the KB PRO series can be retrofitted with a CO2 gassing module. Control ranges 0-1 vol.-% CO2 for plants or 0-20 vol.-% CO2 for cell cultures.</p> <p>KBF PRO 260, 470, 720</p>	
Water treatment	<p>BINDER PURE AQUA Service for the treatment or demineralization of tap water for the humidification systems of BINDER climate chambers. The complete set containing PURE AQUA 300 single-use cartridge, measuring device, and all necessary connecting parts.</p>	
Services	<p>You can access our installation, maintenance, calibration, validation, or warranty services by taking out a Maintenance Service Agreement or by simply getting in touch when you need us.</p>	
BINDER Customized Solution	<p>Using a BINDER series production product as a basis, we develop individual solutions as a single unit or in small batches. All products are tested, certified, and supplied with a full functional guarantee and warranty.</p>	

> Alle Extras Online go2binder.com/de-Optionen

TECHNICAL DATA

Data						
Designation	KBF PRO 130	KBF PRO 260	KBF PRO 470	KBF PRO 720	KBF PRO 1060	KBF PRO 1600
Option model	Standard	Standard	Standard	Standard	Standard	Standard
Performance Data Temperature						
Temperature range	-20...100 °C	-20...100 °C	-20...100 °C	-20...100 °C	-20...100 °C	-20...100 °C
Max. heat compensation at 40°C	450 W	800 W	800 W	1,000 W	1,000 W	1,000 W
Performance Data Climate						
Temperature range with humidity	10...90 °C	10...90 °C	10...90 °C	10...90 °C	10...90 °C	10...90 °C
Humidity range	10...98 % RH	10...98 % RH	10...98 % RH	10...98 % RH	10...98 % RH	10...98 % RH
Temperature uniformity at 25°C and 60% RH	0.2 ± K	0.2 ± K	0.3 ± K	0.3 ± K	0.3 ± K	0.3 ± K
Temperature uniformity at 40°C and 75% RH	0.2 ± K	0.2 ± K	0.3 ± K	0.3 ± K	0.3 ± K	0.3 ± K
Temperature fluctuation at 25°C and 60% RH	0.1 ± K	0.1 ± K	0.1 ± K	0.1 ± K	0.1 ± K	0.1 ± K
Temperature fluctuation at 40°C and 75% RH	0.1 ± K	0.1 ± K	0.1 ± K	0.1 ± K	0.1 ± K	0.1 ± K
Humidity fluctuation at 25°C and 60% RH	1 ± % RH	1 ± % RH	1 ± % RH	1 ± % RH	1 ± % RH	1 ± % RH
Humidity fluctuation at 40°C and 75% RH	1 ± % RH	1 ± % RH	1 ± % RH	1 ± % RH	1 ± % RH	1 ± % RH
Recovery time after door was opened for 30 s at 25°C and 60% RH	1 min	1 min	1 min	1 min	1 min	1 min
Recovery time after door was opened for 30 s at 40°C and 75% RH	3 min	3 min	4 min	5 min	5 min	5 min
Electrical data						
Rated Voltage	208...240 V	208...240 V		208...240 V	208...240 V	208...240 V
Power frequency	50/60 Hz	50/60 Hz	50/60 Hz	50/60 Hz	50/60 Hz	50/60 Hz
Nominal power	1,9 kW	1,6 kW	1,6 kW	1,8 kW	1,9 kW	1,9 kW
Unit fuse	16,0 A	16,0 A	16,0 A	16,0 A	16,0 A	16,0 A
Phase (Nominal voltage)	1~	1~	1~	1~	1~	1~
Dimensions and weights						
Interior volume	127 L	262 L	472 L	727 L	1,070 L	1,610 L
Net weight of the unit (empty)	142 kg	197 kg	249 kg	312 kg	360 kg	450 kg
Load per rack	25 kg	30 kg	40 kg	40 kg	40 kg	40 kg
Permitted load	50 kg	90 kg	90 kg	100 kg	100 kg	100 kg
Wall clearance back	100 mm	100 mm	100 mm	180 mm	180 mm	180 mm
Wall clearance sidewise	100 mm	180 mm	180 mm	180 mm	180 mm	180 mm
Housing dimensions not incl. fittings and connections						
Width net	900 mm	930 mm	930 mm	1,285 mm	1,285 mm	1,795 mm
Height net	1,005 mm	1,396 mm	1,951 mm	1,951 mm	1,951 mm	1,951 mm
Depth net	710 mm	900 mm	900 mm	900 mm	1,175 mm	1,175 mm

Internal Dimensions						
Interior width	656 mm	656 mm	656 mm	1,011 mm	1,011 mm	1,521 mm
Interior height	500 mm	695 mm	1,250 mm	1,250 mm	1,250 mm	1,250 mm
Interior depth	386 mm	575 mm	575 mm	575 mm	847 mm	847 mm
Inner doors	1	1	1	2	2	2
Unit doors	1	1	1	2	2	2
Environment-specific data						
Sound-pressure level at 25°C and 60% RH	46 dB(A)	48 dB(A)	50 dB(A)	50 dB(A)	50 dB(A)	52 dB(A)
Fixtures						
Number of shelves (std./max.)	2/6	2/9	2/16	2/16	2/16	2/16

ORDERING INFORMATION

Interior volume [L]	Power supply - unit fuse	Plug*	Version	Model version	Art.-No.
Model KBF PRO 130					
127	208...240 V 1~ 50/60 Hz -16,0 A	CEE 7/7	Standard	KBFPRO130-230V	9020-0439
Model KBF PRO 260					
262	208...240 V 1~ 50/60 Hz -16,0 A	CEE 7/7	Standard	KBFPRO 260-230V	9020-0440
Model KBF PRO 470					
472	208...240 V 1~ 50/60 Hz -16,0 A	CEE 7/7	Standard	KBFPRO470-230V	9020-0441
Model KBF PRO 720					
727	208...240 V 1~ 50/60 Hz -16,0 A	CEE 7/7	Standard	KBFPRO720-230V	9020-0442
Model KBF PRO 1060					
1,070	208...240 V 1~ 50/60 Hz -16,0 A	CEE 7/7	Standard	KBFPRO1060-230V	9020-0443
Model KBF PRO 1600					
1,610	208...240 V 1~ 50/60 Hz -16,0 A	CEE 7/7	Standard	KBFPRO1600-230V	9020-0444

EXTRACT OF FULFILLED STANDARDS

- ICH Q1A(R2)

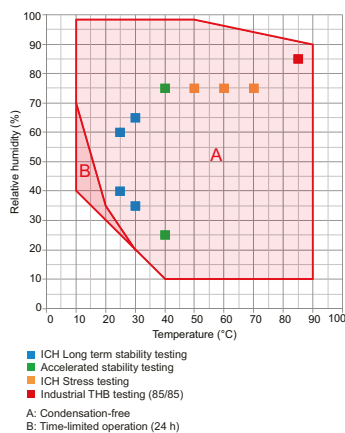

DIMENSIONS AND WEIGHTS

KBF PRO 130

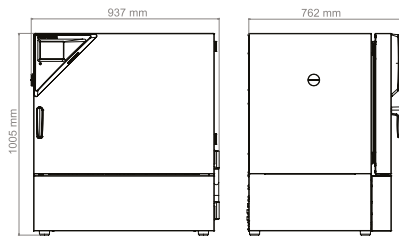

KBF PRO 260

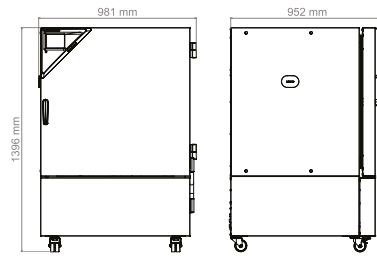

KBF PRO 470

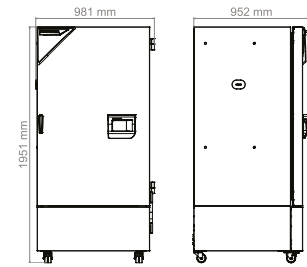

KBF PRO 720

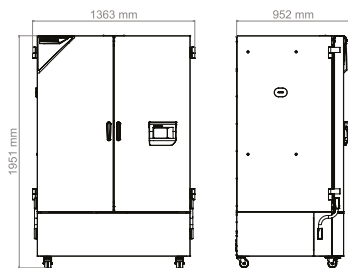

KBF PRO 1060

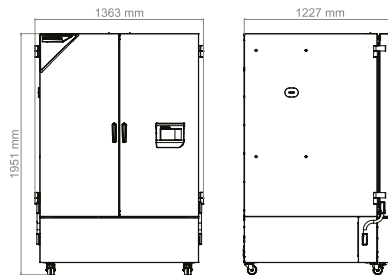

KBF PRO 1600

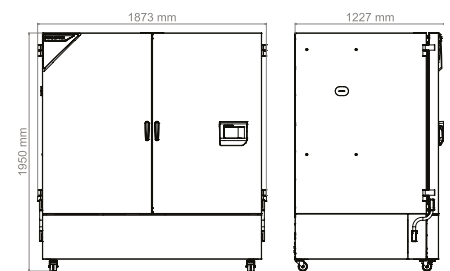

OPTIONS

Designation	Description	KBF	KBF	KBF	KBF	KBF	*	Art.-No.
		PRO 130	PRO 260	PRO 470	PRO 720	PRO 1060		
Access port with silicone plug	left							
	30 mm	•	•	•	•	•	01	8012-2489
	50 mm	•	•	•	•	•	01	8012-2490
	100 mm	-	•	•	•	•	01	8012-2491
	right							
	30 mm	•	•	•	•	•	01	8012-2492
	50 mm	•	•	•	•	•	01	8012-2493
	100 mm	-	•	•	•	•	01	8012-2494
	top							
30 mm	•	•	•	•	•	01	8012-2500	
50 mm	•	•	•	•	•	01	8012-2495	
100 mm	•	•	•	•	•	01	8012-2496	
Alarm output, zero-voltage	Accessible via 3-pin clamping sleeve (max. 24 V - 2.5 A), with acoustic signal that can be switched off	•	•	•	•	•	-	8012-2504
Analog output 4-20 mA	for temperature and humidity values (output not adjustable)	•	•	•	•	•	-	8012-2375
Calibration certificate, expanded	for temperature and humidity; for extending the measurement in center of chamber to include another test value	•	•	•	•	•	-	8012-2576

Designation	Description	KBF PRO 130	KBF PRO 260	KBF PRO 470	KBF PRO 720	KBF PRO 1060	KBF PRO 1600	*	Art.-No.
Calibration certificate, temperature	temperature measurement incl. certificate, 9 measuring points at specified temperature	•	•	•	•	•	•	-	8012-2379
	temperature measurement incl. certificate, 15- 18 measuring points at specified temperature	•	•	•	•	•	•	-	8012-2383
	temperature measurement incl. certificate and 27 measuring points at specified temperature	•	•	•	•	•	•	-	8012-2427
Calibration certificate, temperature and humidity	Measurement in center of chamber at 25°C / 60% RH or at specified test values	•	•	•	•	•	•	-	8012-2438
	temperature (according to DIN12880) and humidity measurement incl. certificate, 27 temperature measuring points and 1 humidity measuring point, at 25 °C / 60 % RH or at specified values	•	•	•	•	•	•	-	8012-2578
Coated heat exchanger	For preventing damage to the aluminum heat exchanger caused by corrosive sample material	•	-	-	-	-	-	-	8012-2582
		-	•	-	-	-	-	-	8012-2583
		-	-	•	-	-	-	-	8012-2584
		-	-	-	•	•	-	-	8012-2585
		-	-	-	-	-	•	-	8012-2586
Door lock	lockable door handle	•	•	•	•	-	-	-	8012-2538
		-	-	-	-	•	•	-	8012-2539
Door lock, electromechanical	can be opened with PIN code via controller	•	•	•	-	-	-	-	8012-2540
		-	-	-	•	•	•	-	8012-2590
Inner chamber, reinforced	max. total load 100 kg	•	-	-	-	-	-	-	8012-2524
	max. total load 180 kg	-	•	-	-	-	-	-	8012-2525
	max. total load 200 kg	-	-	•	-	-	-	-	8012-2526
		-	-	-	•	-	-	-	8012-2527
		-	-	-	-	•	-	-	8012-2528
Interior lighting	With climate-resistant LEDs, switches when the unit door is opened	•	•	•	-	-	-	-	8012-2562
		-	-	-	•	•	-	-	8012-2566
		-	-	-	-	-	•	-	8012-2570
Shipping pallet	with unloading ramp for installing unit without forklift	-	•	•	•	•	•	-	8012-2548
Specimen temperature display	Flexible Pt 100 indoor temperature sensor, for object temperature display or control	•	•	•	•	•	•	-	8012-2554
Swivel casters, height-adjustable	For horizontal alignment of the unit on uneven floors	-	•	•	•	•	•	-	8012-2544

ACCESSORIES

Designation	Description	KBF PRO 130	KBF PRO 260	KBF PRO 470	KBF PRO 720	KBF PRO 1060	KBF PRO 1600	*	Art.-No.
APT-COM™ 4 GLP-Edition	for working under GLP-compliant conditions. Measured values are documented in a tamper-proof way in line with the requirements of FDA Regulation 21 CFR 11.								
	version 4, GLP edition	•	•	•	•	•	•	-	9053-0042

Designation	Description	KBF	KBF	KBF	KBF	KBF	KBF	*	Art.-No.
		PRO 130	PRO 260	PRO 470	PRO 720	PRO 1060	PRO 1600		
APT-COM™ 4 PROFESSIONAL-Edition	convenient unit and user management built on the BASIC edition. Suitable for networking up to 100 units.								
	version 4, PROFESSIONAL edition	•	•	•	•	•	•	-	9053-0040
Base	With swivel casters, for mobile installation or leveling of the unit or stack of units	•	-	-	-	-	-	-	9051-0045
BINDER PURE AQUA SERVICE	System for preparation or complete desalination of tap water, complete set containing PURE AQUA 300 single-use cartridge, measuring device, and all necessary connecting parts	•	•	•	•	•	•	-	8012-0759
BINDER PURE AQUA SERVICE, accessories	Single-use, replacement cartridge for BINDER PURE AQUA System	•	•	•	•	•	•	-	6011-0165
Coated heat exchanger	For preventing damage to the aluminum heat exchanger caused by corrosive sample material	-	-	-	-	-	•	-	8012-2586
Converter, voltage	to operate the device at a nominal voltage of 120 V 1 ph 60 Hz								
	240 V option model	•	•	•	•	•	•	-	8009-0821
CO ₂ gassing module	BINDER CO ₂ gassing module 0-1%, with NDIR CO ₂ sensor and analog output 4-20 mA	-	•	•	•	•	•	-	8012-2140
	BINDER CO ₂ gassing module 0-20%, with NDIR CO ₂ sensor and analog output 4-20 mA	-	•	•	•	•	•	-	8012-2138
Door lock	lockable door handle	-	-	-	-	-	•	-	8012-2539
Door lock, electromechanical	can be opened with PIN code via controller	-	-	-	-	-	•	-	8012-2590
ICH light module	BINDER ICH-Q1B light module consisting of a VIS cassette and a UVA cassette as well as an independent power supply	-	•	•	-	-	-	-	8012-2441
		-	-	-	•	-	-	-	8012-2442
ICH light module with LQC	BINDER ICH-Q1B light module with light-dose control consisting of a VIS cassette, a UVA cassette, a spherical VIA sensor, a spherical UVA sensor as well as an independent power supply	-	•	•	-	-	-	-	8012-2443
		-	-	-	•	-	-	-	8012-2444
Interior lighting	With climate-resistant LEDs, switches when the unit door is opened	-	-	-	-	-	•	-	8012-2570

Designation	Description	KBF	KBF	KBF	KBF	KBF	KBF	*	Art.-No.
		PRO 130	PRO 260	PRO 470	PRO 720	PRO 1060	PRO 1600		
LED light bars	Basic set consisting of 2 pieces, attachment material, control unit for max. 4 light strips, 100-240 V, 50/60 Hz								
	Basic set 300, length 30 cm	•	•	•	–	–	–	-	8012-1107
	Basic set 500, length 50 cm	•	•	•	•	•	•	-	8012-1108
	Basic set 900, length 90 cm	–	–	–	•	•	•	-	8012-1109
	Expansion set consisting of 2 pieces, attachment material: clips. For expanding the basic set of light bars								
	Expansion set 300, length 30 cm	•	•	•	–	–	–	-	8012-1716
	Expansion set 500, length 50 cm	•	•	•	•	•	•	-	8012-1717
Light module for plants	Expansion set 900, length 90 cm	–	–	–	•	•	•	-	8012-1718
	BINDER LED plant light module consisting of 16 LED strip lights, 3-channel controller and fresh air pump as well as independent power supply	–	•	•	•	•	•	-	8012-2439
	pH-neutral detergent	•	•	•	•	•	•	-	8012-2250
Qualification documents	concentrated, for gentle remove of residual contaminants; 1 kg								
	IQ/OQ/PQ documents – supporting documents for validation performed by customers, according to customer requirements, PQ section added to qualification folder IQ/OQ; parameters: temperature and humidity values								
	Digital in PDF format	•	•	•	•	•	•	-	7057-0006
	Hard copy inside folder	•	•	•	•	•	•	-	7007-0006
	IQ/OQ documents – supporting documents for validation performed by customers, consisting of: IQ/OQ checklists incl. calibration guide and comprehensive unit documentation; parameters: temperature and humidity values								
	Digital in PDF format	•	•	•	•	•	•	-	7057-0002
Reinforced rack	Hard copy inside folder	•	•	•	•	•	•	-	7007-0002
	Shelf rack in set with pair of retaining rails (U rails), made entirely of stainless steel								
	Load-bearing capacity 50 kg	•	–	–	–	–	–	-	8012-2412
		–	•	•	–	–	–	-	8012-2413
	Load-bearing capacity 80 kg	–	–	–	•	–	–	-	8012-2414
	–	–	–	–	•	–	-	8012-2415	
Shelf rack, perforated	Shelf rack in set with pair of retaining rails (U rails), made entirely of stainless steel								
	Load-bearing capacity 25 kg	•	–	–	–	–	–	-	8012-2406
		–	•	•	–	–	–	-	8012-2407
	Load-bearing capacity 40 kg	–	–	–	•	–	–	-	8012-2408
		–	–	–	–	•	–	-	8012-2409
	–	–	–	–	–	•	-	8012-2410	
Shipping pallet	with unloading ramp for installing unit without forklift	–	–	–	–	–	•	-	8012-2548
Stacking adapter	For safe stacking of two identical units	•	–	–	–	–	–	-	9051-0048

Designation	Description	KBF	KBF	KBF	KBF	KBF	KBF	*	Art.-No.	
		PRO 130	PRO 260	PRO 470	PRO 720	PRO 1060	PRO 1600			
Standard rack	Shelf rack in set with pair of retaining rails (ball bearing mounted telescopic rails), made entirely of stainless steel	-	•	•	-	-	-	-	8012-2384	
		-	-	-	•	-	-	-	8012-2385	
		-	-	-	-	•	-	-	8012-2386	
		-	-	-	-	-	•	-	8012-2387	
	Load-bearing capacity 40 kg	Shelf rack in set with pair of retaining rails (U rails), made entirely of stainless steel	•	-	-	-	-	-	-	8012-2389
			-	•	•	-	-	-	-	8012-2390
			-	-	-	•	-	-	-	8012-2391
			-	-	-	-	•	-	-	8012-2392
			-	-	-	-	-	•	-	8012-2393
			-	-	-	-	-	-	•	-
Swivel casters, height-adjustable	For horizontal alignment of the unit on uneven floors	-	-	-	-	-	•	-	8012-2544	
Water supply	External, free-standing, set consisting of 20-liter fresh water canister with pump and level sensor and 20-liter waste water canister	•	•	•	•	•	•	-	8012-2592	

SERVICES

Designation	Description	*	Art.-No.
1-year warranty extension	The warranty is extended by 1 year from the delivery date, wear parts are excluded	-	DL50-0030
BRONZE 3-year maintenance contract	Maintenance service as contractually agreed, visual inspection of mechanical and electrical components, check of control response, 20% discount on spare parts	-	DL20-0710
Execution of IQ/OQ	Execution of IQ/OQ in accordance with qualification folder	-	DL42-0300
Execution of IQ/OQ/PQ	Execution of IQ/OQ/PQ in accordance with qualification folder	-	DL44-0500
GOLD 3-year maintenance contract	Maintenance service as contractually agreed, visual inspection of mechanical and electrical components, check of control response, 20% discount on spare parts, testing of all key functions, replacement of wear parts, calibration of one temperature/humidity value, including certificate	-	DL20-0920
Maintenance	One-off maintenance service in accordance with maintenance schedule. Visual inspection of mechanical and electrical components, testing of all key functions. Calibration of a test temperature specified by the user in center of usable space without certificate	-	DL20-0613
SILVER 3-year maintenance contract	Maintenance service as contractually agreed, visual inspection of mechanical and electrical components, check of control response, 20% discount on spare parts, testing of all key functions, calibration of one test temperature specified by the user in the center of the usable space, without certificate	-	DL20-0820
Temperature and humidity calibration	Expansion – Temperature and humidity calibration with 1 measuring point in center of chamber with 1 specified pair of values, including certificate	-	DL30-0302
	Temperature and humidity calibration with 1 measuring point in center of chamber with 1 specified pair of values, including certificate	-	DL30-0340
Temperature and humidity measurement, 9-1 measuring points	Temperature measurement with 9 temperature measuring points and 1 humidity measuring point in center of chamber with a pair of values specified by the user, including certificate	-	DL30-0309
Temperature and humidity measurement, 18-1 measuring points	Temperature measurement with 18 temperature measuring points and 1 humidity measuring point in center of chamber with a pair of values specified by the user, including certificate	-	DL30-0318
Temperature and humidity measurement, 27-1 measuring points	Temperature measurement with 27 temperature measuring points and 1 humidity measuring point in center of chamber with a pair of values specified by the user, including certificate	-	DL30-0327
Temperature and humidity measurement according to DIN12880	Temperature measurement in accordance with DIN 12880 with 27 temperature measuring points and 1 humidity measuring point in center of chamber with a pair of values specified by the user, including certificate	-	DL30-0427

Designation	Description	*	Art.-No.
Unit commissioning	Connect the unit to the customer-side connections (electricity, water, wastewater, gas), basic functions check, brief operating instructions. (excl.: unpacking, setup, controller instructions, programming, installation work)	-	DL10-0300
Unit instructions	Instruction regarding operating principle and basic functions of the unit, operation of the control electronics including programming	05	DL10-0700

BINDER products

CO₂ incubators

Incubators

Cooling incubators

Growth chambers

Ultralow temperature freezers

Drying and heating chambers

Safety drying chambers

Vacuum drying chambers

Constant climate chambers

Dynamic climate chambers

Battery test chambers

Walk-in-chambers

Multi Management Software



Never miss a product novelty -
Subscribe and keep up to speed with
the BINDER monthly newsletter.

Subscription

go2binder.com/en-newsletter-subscription



Best conditions for your success

BINDER GmbH
Tuttlingen, Germany

Tel +49 7462 2005 0
info@binder-world.com
www.binder-world.com

BINDER Asia Pacific (Hong Kong) Ltd.
Kowloon, Hong Kong, P.R. China

Tel +852 39070500
asia@binder-world.com

**BINDER Environmental Testing
Equipment (Shanghai) Co., Ltd.**
Shanghai, P.R.China

Tel +86 21 685 808 25
china@binder-world.com

BINDER Inc.
Bohemia, NY, USA

Tel +1 631 224 4340
usa@binder-world.com